

Multi-clamping system

Multi-clamping systems are mainly used for machining large workpiece batches.

The system can be optionally set up for one or more workpieces.

Depending on the workpiece size and clamping rail length, several workpieces can thus be clamped simultaneously.

Due to the large component selection of the multiple clamping system (clamping rails, fixed jaws, wedge clamps and accessories) workpieces of different quantities and dimensions can be machined without problems and with optimised set-up times.

The user can choose between single-sided or double-sided types of wedge clamps.

The teeth on the clamping rails are precision-ground and guarantee secure and precise fastening of the fixed stops. By mounting several clamping rails along and across the table, the working area and the number of workpieces can be effectively optimised.

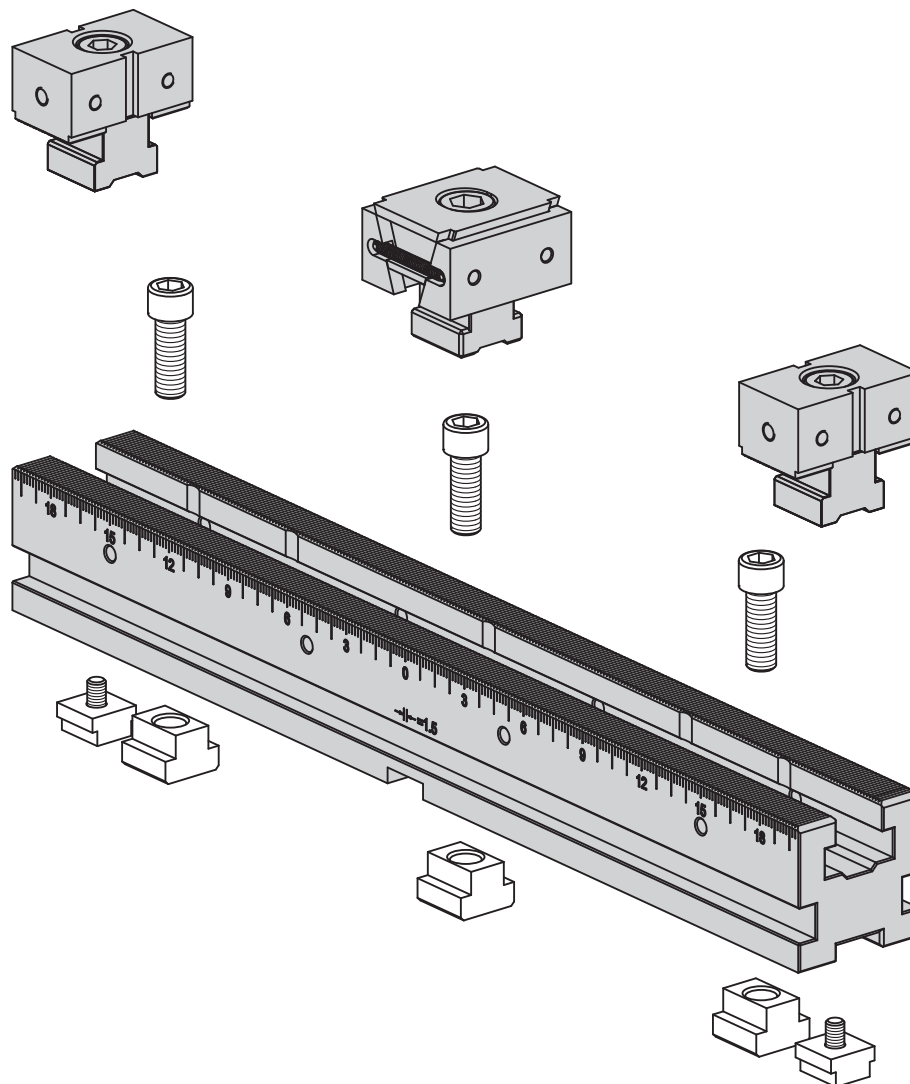

Interfaces

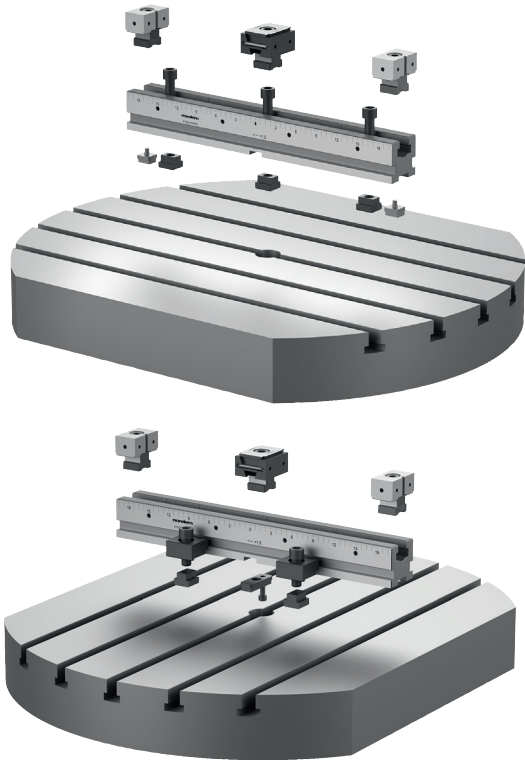

Mounting of the multi-clamping system along and across a T-slot machine table is possible. Alignment with slot keys. Secured using screws or clamping claws.

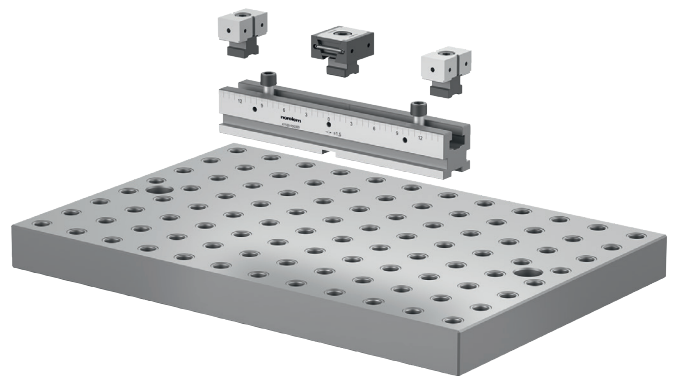

Mounting the multi-clamping system on a grid system. Positioned and fastened using shoulder screws.

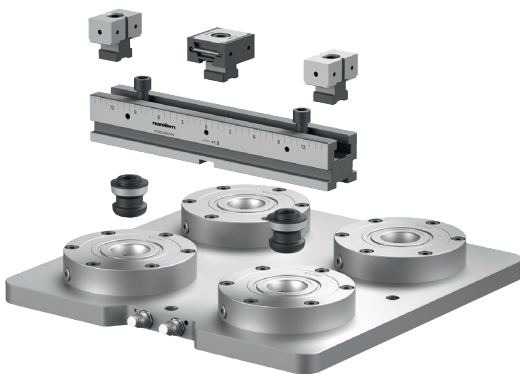

Adaptation of the multi-clamping system to a conventional zero-point clamping system. Fits on 200 mm gauge size. $\text{Ø}25\text{H6}$ locating hole and M12 fastening screw.

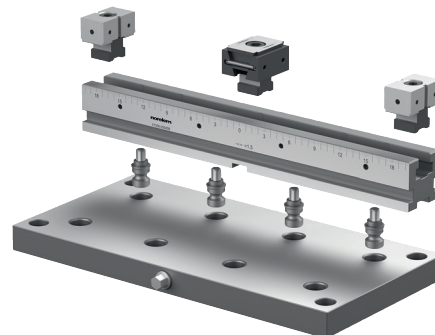

Adaptation of the multi-clamping system to a mechanical zero-point clamping system. Fits on 96mm gauge size. $\text{Ø}16\text{H6}$ locating hole and M10 fastening thread.

Example of a multi-clamping system

Application of the multi-clamping system with different workpieces.
Wedge clamps used here have the force coming from one side.
Depending on the workpiece size, several workpieces can be clamped using identical clamping rails.
The multi-clamping system can be modified flexibly and quickly.

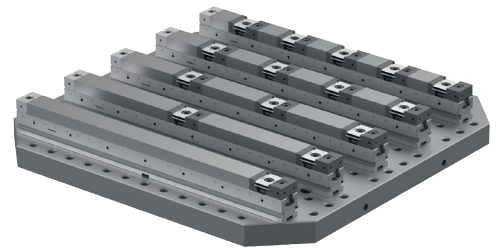

Multi-clamping system aligned and secured on pallet with T-slots.
Multi-clamping system set up for 20 identical workpieces.
Space-saving fixed jaws with one mounting screw.
Wedge clamps constructed as double-sided clamping element.

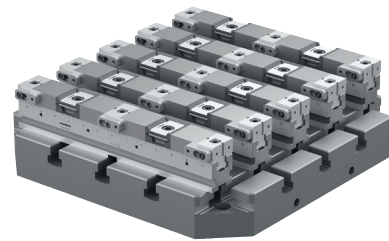

Flexible application of the multi-clamping system on an octagonal workholding tower.
With this clamping arrangement, many workpieces can be clamped simultaneously to extend the machine running time.



Multi-clamping system mounted on an interchangeable pallet.
The workpieces can be reloaded externally to the machine to extend the machine running time.
With the double-sided arrangement of the wedge clamps, both plates can be clamped simultaneously.

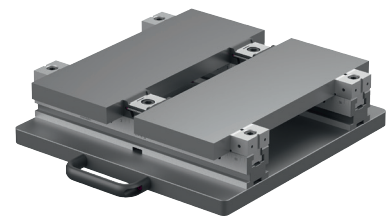

Multi-clamping system mounted on an interchangeable pallet.
Attachment jaws with prisms are screwed onto the fixed stops of the multi-clamping system.
Wedge clamps with machining allowance are used as clamping elements. The workpiece contour is machined into the jaw face.

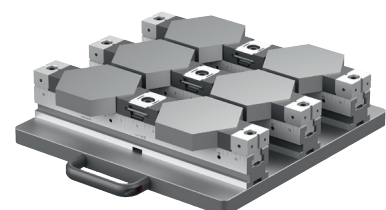

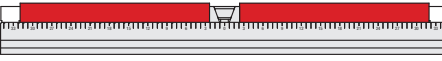

Maximum workpiece size

Maximum workpiece size for types double-sided wedge clamps and fixed jaw ES

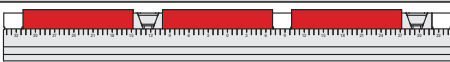
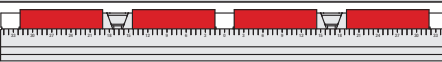
Clamping rails	1 pcs.	2 pcs.
		
	B=50	B=50
L=300	193	96
L=400	292	146
L=500	394	197
L=600	493	246
L=700	592	296

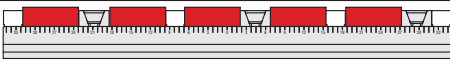
Clamping rails	3 pcs.	4 pcs.
		
	B=50	B=50
L=300	39	29
L=400	72	54
L=500	106	79
L=600	139	104
L=700	172	129

Clamping rails	5 pcs.	6 pcs.
		
	B=50	B=50
L=300	8	6
L=400	27	23
L=500	48	40
L=600	68	56
L=700	87	73

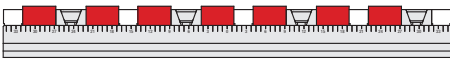
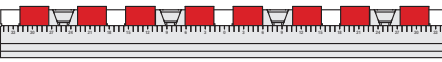

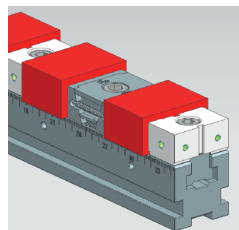
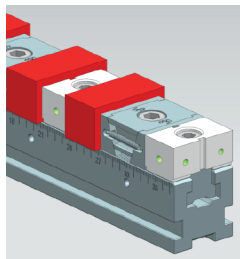
Clamping rails	7 pcs.	8 pcs.
		
	B=50	B=50
L=300	-	-
L=400	9	8
L=500	23	20
L=600	37	33
L=700	51	45







Combination of clamping rails for multi-clamping system 41500.
Wedge clamp 41501 and
Fixed jaw ES for multi-clamping system 41502.

Maximum workpiece size

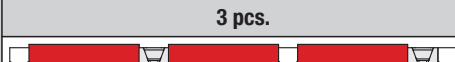
Maximum workpiece sizes for the types double-sided wedge clamp and fixed jaw DS

Clamping rails	1 pcs.	2 pcs.
		
	B=50	B=50
L=300	164	82
L=400	263	131
L=500	365	182
L=600	464	232
L=700	563	281

Clamping rails	3 pcs.	4 pcs.
		
	B=50	B=50
L=300	24	18
L=400	57	43
L=500	91	68
L=600	124	93
L=700	157	118

Clamping rails	5 pcs.	6 pcs.
		
	B=50	B=50
L=300	-	-
L=400	16	13
L=500	36	30
L=600	56	47
L=700	76	63

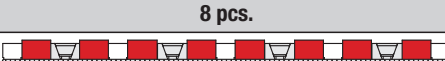
Clamping rails	7 pcs.	8 pcs.
		
	B=50	B=50
L=300	-	-
L=400	-	-
L=500	13	11
L=600	27	24
L=700	41	36

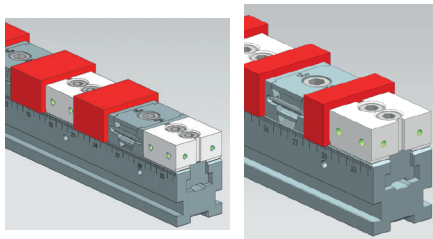

Combination of clamping rails for multi-clamping system 41500.
Wedge clamp 41501 and Fixed jaw DS for multi-clamping system 41502-05.

Maximum workpiece size

Maximum workpiece sizes for the types wedge clamp with fixed jaw

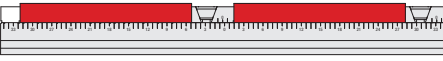
Clamping rails	1 pcs.	2 pcs.
		
	B=50	B=50
L=300	203	68
L=400	302	118
L=500	404	169
L=600	503	218
L=700	602	268

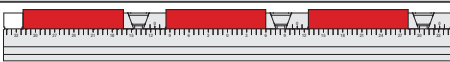
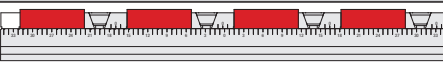
Clamping rails	3 pcs.	4 pcs.
		
	B=50	B=50
L=300	23	-
L=400	56	26
L=500	90	51
L=600	123	76
L=700	156	101

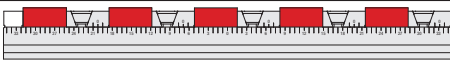
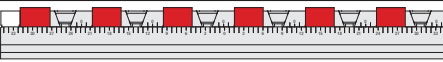
Clamping rails	5 pcs.	6 pcs.
		
	B=50	B=50
L=300	-	-
L=400	7	-
L=500	27	12
L=600	47	28
L=700	67	45

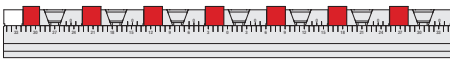
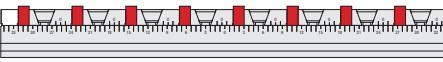
Clamping rails	7 pcs.	8 pcs.
		
	B=50	B=50
L=300	-	-
L=400	-	-
L=500	-	-
L=600	15	5
L=700	29	17

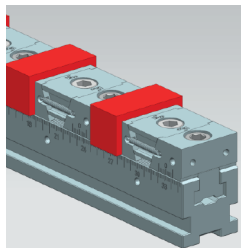

Combination of clamping rails for multi-clamping system 41500.
 Wedge clamp with fixed jaw for multi-clamping system 41501-05 and 1x fixed jaw ES for multi-clamping system 41502.