



## Descrizione

### Materiale:

Acciaio da bonifica.  
Maniglia in plastica.

### Versione:

Trattato termicamente e brunito.  
Maniglia nera.

### Nota:

Le staffe girevoli vengono utilizzate principalmente laddove i punti di serraggio devono rimanere liberi per il posizionamento o la rimozione di pezzi.

\* Forza manuale consentita per la maniglia.

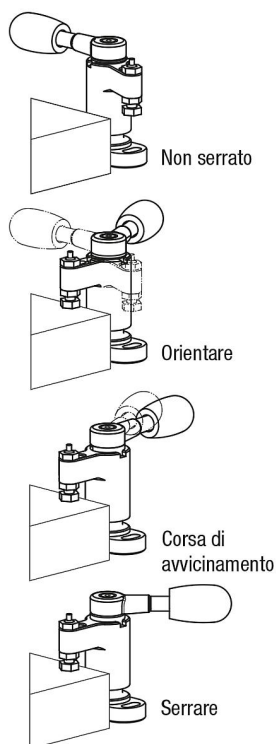

Disegni

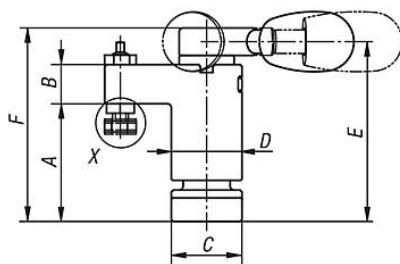

Esecuzione destra

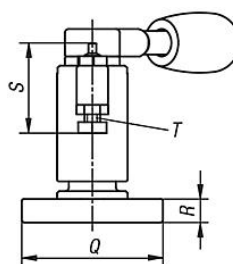

Esecuzione sinistra

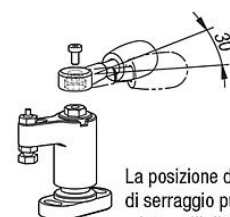
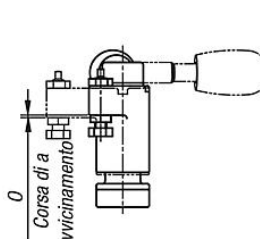
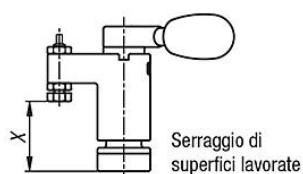
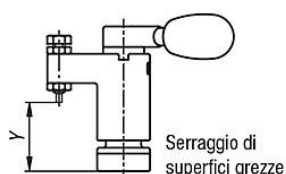
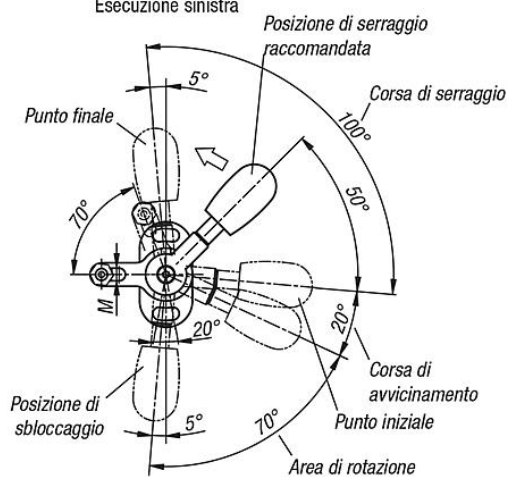
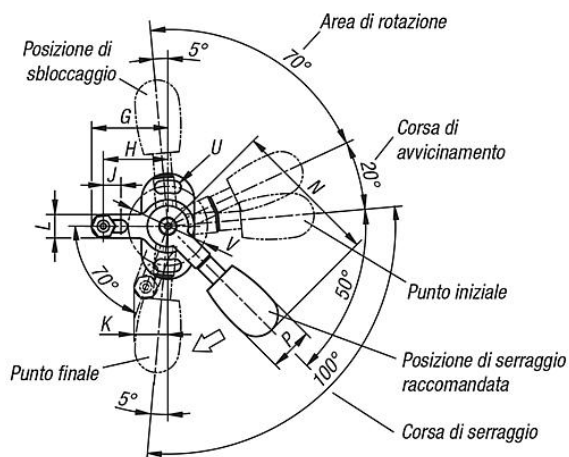
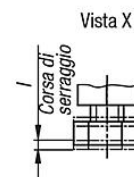

La posizione della manopola di serraggio può essere regolata a intervalli di 30°.

Sintesi articoli

N. ordine a sinistra	N. ordine a destra	A	B	C	D	E	F	G	H	I	J	K	L	M	N	O	P	Q	R	S	T	U	V	X min.	X max.	Y min.	Y max.	Forza di bloccaggio N	Forza manuale FH N
04364-0100	04364-1100	30	10	18	18	45,8	49	26	22	1	6	11,5	8	4,3	50	0,8	15	36	6	22,8	M4	4,3	27	22,3	25,3	21,9	24,9	1100	100*
04364-0150	04364-1150	40	14	23	23	61,3	66	35	30	1,4	8	15,3	10	5,3	63	1,1	20	45	8	28,5	M5	5,3	34	30,6	34	31,5	34,9	1800	150*
04364-0200	04364-1200	50	18	30	30	76,5	82	45	37	1,5	8	20,7	16	8,4	80	1,4	26	65	12	45,5	M8	8,4	48	31,7	39,7	32,7	40,7	2200	200*
04364-0300	04364-1300	60	22	40	40	93	100	55	45	1,9	8	25,4	20	10,4	100	1,7	33	85	15	57	M10	10,5	64	35,5	46,9	38	49,4	3500	300*